

Pioneer Dj

DJ MIXER

DJM-750MK2

[pioneeardj.com/support/
rekordbox.com](http://pioneeardj.com/support/rekordbox.com)

For FAQs and other support information for this product, visit the above site.

Operating Instructions

Contents

How to read this manual

Thank you for purchasing this Pioneer DJ product.

Be sure to read this manual and the "Operating Instructions (Quick Start Guide)" included with the unit. Both documents include important information that you should understand before using this product.

- In this manual, names of channels and buttons on the product, menus in the software, etc., are enclosed in square brackets ([]). (e.g. [MASTER] channel, [ON/OFF], [Start] menu)
- Screens, external appearance, and software and hardware specifications described in this manual are based on the product that is still under development and may differ from the final specifications.
- Depending on your operating system, the web browser settings, etc., the procedures described in this manual may differ from actual operations.
- Note that the language on the software screens explained in this unit may differ from the language used on actual screens.

01 Before start

Features.....	3
---------------	---

02 Part names and functions

Rear panel	4
Control Panel	5

03 Connections

Connecting input terminals.....	7
Connecting output terminals	8
Connecting to the control panel.....	9

04 Operation

Basic Operation	10
Advanced Operations.....	11

05 Types of effects

Types of SOUND COLOR FX effects.....	14
Types of BEAT FX	14

06 Use rekordbox dj

rekordbox.....	16
Installing rekordbox.....	16
Launch rekordbox.....	17
Preparing rekordbox.....	17
Adding track files to [Collection].....	18

07 Using the DVS

The settings of rekordbox dj.....	19
Setting the control signals.....	19

08 Using applications other than rekordbox dj

Installing the driver software	20
--------------------------------------	----

09 Changing the settings

Setting preferences	22
Changing the settings	22
Returning to default settings.....	22
About the auto standby function.....	22
About the talk over function.....	23
Setting utility software.....	23
Checking the latest information on the driver software.....	24
[Mixer Audio Output] pull-down menu list	24

10 Additional information

Troubleshooting.....	25
Block Diagram	27
Trademarks and registered trademarks	28
Cautions on copyrights	28

Before start

Features

This unit is a 4-channel DJ mixer that continues the tradition of the DJM series from Pioneer DJ, the global standard for the disco/club scene. This unit is equipped with the EQ/fader curve, SOUND COLOR FX, BEAT FX, and SEND/RETURN functions that were newly developed for the DJM-900NXS2, which is the permanent equipment in a club. This allows a broad range of DJ performances. Additionally, it features a design that offers high sound quality, excellent reliability, and an easy-to-use panel layout, as well as the ability to connect to a variety of devices such as USB sound cards that allow connection to PC, Mac, or iOS devices, providing a high level of support for DJ performances of all kinds.

EQ & FADER

This unit features the same curve characteristics offered in the EQ curve and fader curve revised in the DJM-900NXS2, allowing the creation of natural mixes that sound exactly the way you want. **3 BAND EQ/ISOLATOR:** Equipped with a three-band equalizer that allows the levels of the high, mid, and low frequency ranges to be adjusted separately. In addition to changing the tone to suit your preferences, this unit also features an isolator function that mutes the sound in the relevant frequency range when you rotate a control to the left.

CHANNEL FADER: Equipped with the same characteristics as the channel fader curve of the DJM-900NXS2 that is a permanent equipment in a club. Select curves suited to quick mixes or smooth long mixes to create a mix that sounds exactly the way you want.

MAGVEL FADER: Equipped with magnetic crossfader developed by Pioneer DJ. Highly durable hardware that is built to withstand more than 10 million operations, and precise operability is perfect for frenetic scratch playing.

FX

This unit features the acclaimed SOUND COLOR FX, BEAT FX, and SEND/RETURN found on the DJM-900NXS2 used in many clubs, allowing a variety of DJ performances.

SOUND COLOR FX: Equipped with four types of effects. Simply rotate the **[COLOR]** control for each channel to obtain effects and adjust the sound qualities of the music tracks input to each channel, creating impromptu performances. Additionally, adjust the **[PARAMETER]** to obtain more diverse expression.

BEAT FX: Equipped with eleven types of BEAT FX. Link a range of effects to BPM to add more variety to a performance. Equipped with **[FX FREQUENCY]** that allows you to choose the frequency band to add effects for greater freedom when performing.

SEND/RETURN: An independent SEND/RETURN section is provided, allowing an external effects unit to be used at the same time as onboard FX. In addition to the existing method of using insert-style SEND/RETURN effects for handling RMX series effects, the RETURN AUX method of assigning RETURN sound to a channel and thus allowing the original sound to be combined freely with the effects sound to produce a more personal sound. In addition to external hardware effects unit, countless effects applications on iOS devices can be utilized through a simple, single-USB cable connection.

STANDARD LAYOUT

This unit retains the control panel layout of the Pioneer DJ DJM series, a world standard for DJ mixers. The simple, easy-to-understand control panel layout makes DJ performance easy, and allows performance in the same way as the DJM-900NXS2, a standard for use in clubs.

“rekordbox dj” and “rekordbox dvs”

This unit comes with a license key for “rekordbox dj” and “rekordbox dvs”, which are DJ applications to make tracks on your PC/Mac to be played with a turn table/Control Vinyl. This unit is equipped with an internal sound card, enabling you to control “rekordbox dj” and “rekordbox dvs” by only connecting a USB cable to your PC/Mac, without complicated settings. Only the unit, turn table/Control Vinyl, and PC/Mac are required to use these applications.

rekordbox

rekordbox is composite software that facilitates track management and DJ performances. The rekordbox DJ performance function is called rekordbox dj. For details, refer to *Use rekordbox dj* (page 16).

Part names and functions

Rear panel

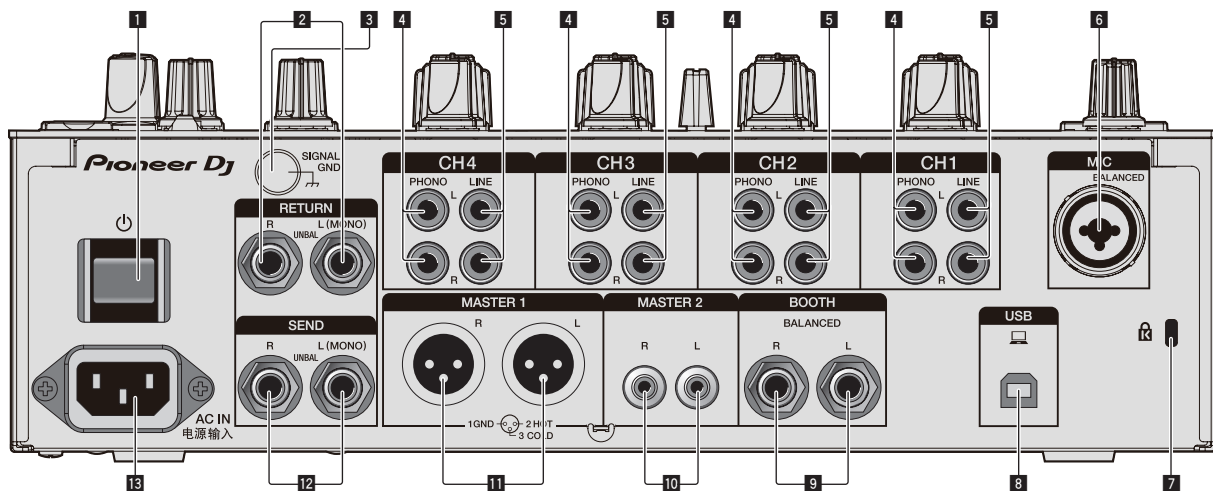

1 button (page 10)

Turns this unit on and off.

2 RETURN terminals (page 8)

Connect to output terminals of an external effects unit. If a cable is connected to the [L (MONO)] terminal only, the input to the [L (MONO)] terminal is also input to the [R] channel.

3 SIGNAL GND terminal (page 7)

Connect a ground wire of an analog player to reduce noise that occurs when an analog player is connected.

4 PHONO terminals (page 7)

Connect a phono level (MM cartridge) output device. Do not input line level signals.

5 LINE terminals (page 7)

Connect a DJ player or a line level output component.

6 MIC terminal (page 7)

Connect a microphone.
Phantom power supply is not supported.

7 Kensington security slot

8 USB terminal (page 7)

Use the USB cable included to connect to a PC.

9 BOOTH terminals (page 8)

These are output terminals for a booth monitor.
Be sure to use these as balanced outputs.

10 MASTER2 terminals (page 8)

Connect to analog input terminals of a power amplifier, etc.

11 MASTER1 terminals (page 8)

Connect to analog input terminals of a power amplifier, etc.
Be sure to use these as balanced outputs.

Be careful not to accidentally insert the power cord of another unit.

Do not connect the terminal that can supply phantom power.

12 SEND terminals (page 8)

Connect to input terminal of an external effects unit. If a cable is connected to the [L (MONO)] terminal only, a monaural audio signal is output.

13 AC IN

Connect to a power outlet with a supplied power cord. Connect the power cord after all the connections are completed.
Be sure to use the supplied power cord.

Control Panel

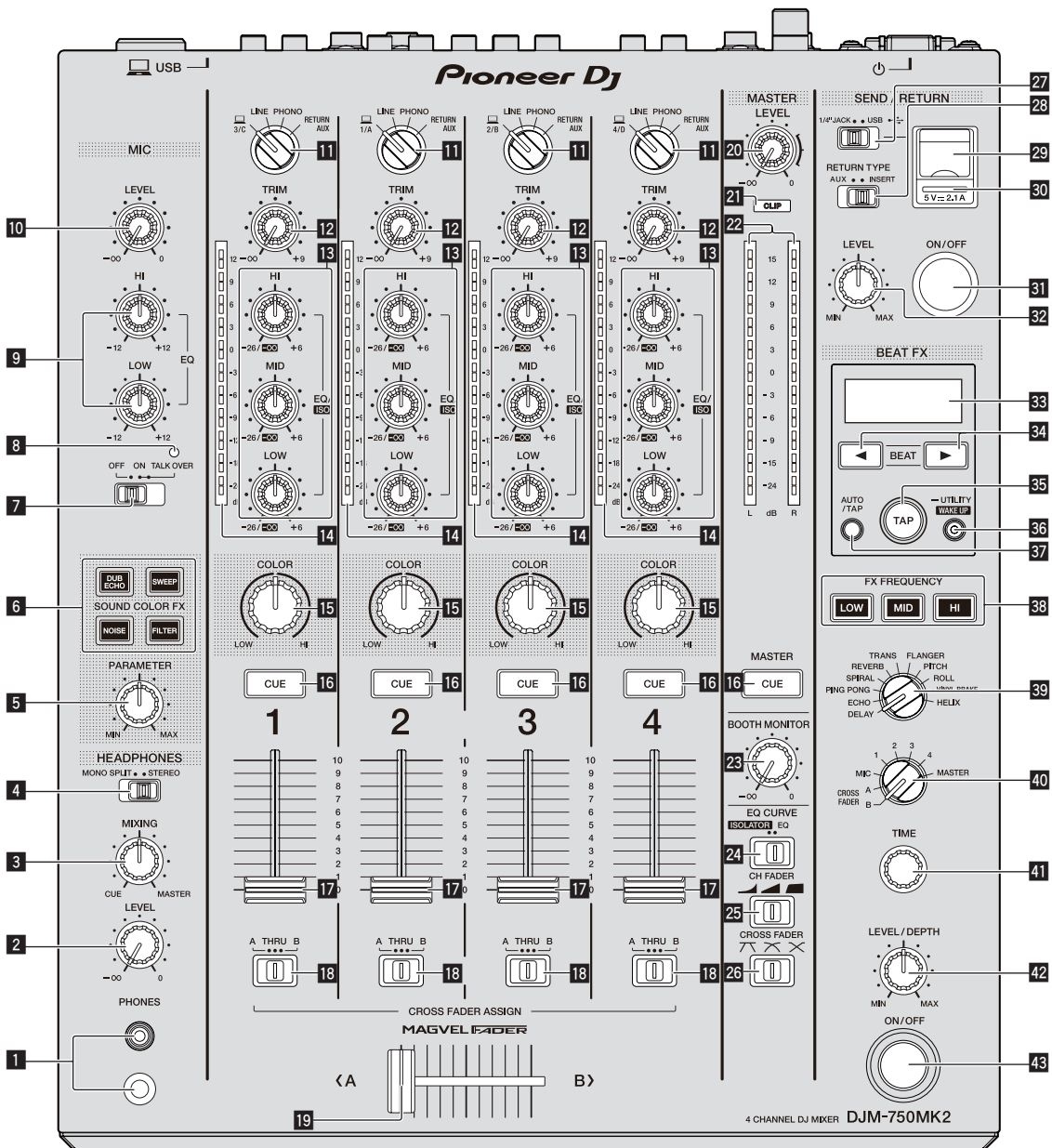

1 PHONES terminal (page 10)

Connect headphones.
1/4" stereo phone plugs and 3.5 mm stereo mini plugs are supported.

2 LEVEL control (page 10)

Adjusts the level of sound output from the headphones.

3 MIXING control (page 10)

Adjusts the monitor volume balance for the sound of the [MASTER] channel and the sound of the channel for which the [CUE] button is pressed.

4 MONO SPLIT, STEREO selector switch (page 10)

Sets the distribution of the monitor sound output from the headphones.

5 PARAMETER control (page 11)

Adjusts the SOUND COLOR FX parameter.

6 SOUND COLOR FX buttons (page 11)

Turns on and off SOUND COLOR FX.

7 OFF, ON, TALK OVER selector switch (page 11)

Turns the microphone on and off.

8 Microphone indicator (page 11)

9 EQ (HI, LOW) controls (page 11)

Adjusts the sound quality of the microphones.

10 MIC LEVEL control (page 11)

Adjusts the level of sound output from the microphone.

11 Input selector switches (page 10)

Selects the input source for each channel from the components connected to this unit.

12 TRIM control (page 10)

Adjusts the level of sound input to each channel.

13 EQ/ISO (HI, MID, LOW) controls (page 10)

Adjusts the sound quality of each channel.

14 Channel Level Indicator (page 10)

Displays the sound level of each channel before it passes through the channel faders.

15 COLOR control (page 11)

This changes the parameters of the SOUND COLOR FX of the different channels.

16 CUE button (page 10)

Presses the [CUE] button of the channel to be monitored.

17 Channel Fader (page 10)

Adjusts the level of sound output from each channel.

18 CROSS FADER ASSIGN (A, THRU, B) selector switch (page 10)

Sets the output destination of each channel to [A] or [B].

19 Crossfader (page 10)

Outputs audio signals assigned by the crossfader assign switch corresponding to the curve characteristics selected by [CROSS FADER] (Crossfader Curve Selector Switch).

20 MASTER LEVEL control (page 10)

Adjusts the audio level output from the [MASTER1] and [MASTER2] terminals.

21 CLIP indicators

Blinks when excessive volume level is output from the [MASTER1] or [MASTER2] terminals.

- Blinks slowly: indicates that the sound is about to be distorted.
- Blinks fast: indicates that the sound is distorted.

22 Master Level Indicator (page 10)

Displays the level of sound output from the [MASTER1] and [MASTER2] terminals.

23 BOOTH MONITOR control (page 11)

Adjusts the level of sound output from the [BOOTH] terminal.

24 EQ CURVE (ISOLATOR, EQ) selector switch (page 10)

Sets the function of the [EQ/ISO (HI, MID, LOW)] controls.

25 CH FADER ( selector switch (page 10)

Sets the curve characteristics of the channel fader.

26 CROSS FADER ( selector switch (page 10)

Sets the curve characteristics of the crossfader.

27 SEND/RETURN (1/4" JACK,  selector switch (page 12)

Sets the input and output sources for the SEND/RETURN channel. You can select the device connected to the [SEND/RETURN] terminals on the rear panel of this unit or the device connected to the mobile device connection terminal on the operation panel.

28 RETURN TYPE (AUX, INSERT) selector switch (page 12)

Sets the SEND/RETURN method.

29 Mobile device connection terminal (USB port) (page 9)

Connect a mobile device.

30 USB connection indicator (page 9)

Lights when a mobile device compatible with the mobile device connection terminal (USB port) is connected. Blinks when a non-compatible device is connected.

31 SEND/RETURN ON/OFF button (page 12)

Turns SEND/RETURN on and off.

32 SEND/RETURN LEVEL control (page 12)

Adjusts the sound level of SEND/RETURN.

33 Main display (page 11)

Displays the effect name, BPM, effect parameter, etc.

34 BEAT ◀, ▶ buttons (page 11)

Sets the beat fraction for synchronizing the effect sound.

35 TAP button (page 11)

When the BPM measurement mode is set to [TAP], tap this button with a finger to input the BPM manually.

36 UTILITY (WAKE UP) button (page 22)

- **UTILITY:** Press and hold this button to display the [UTILITY] screen. This button lights when the [UTILITY] screen is displayed. Press this button when the [UTILITY] screen is displayed to return to the normal screen.
- **WAKE UP:** Lights up when this unit enters standby mode. Press this button in standby mode to exit standby mode.

37 AUTO/TAP button (page 11)

Sets the BPM measurement mode.

38 FX FREQUENCY button (page 12)

Sets the range to apply BEAT FX. BEAT FX is applied to the lit button.

39 Beat effect selector switch (page 12)

Sets the BEAT FX type.

40 Effect channel selector switch (page 12)

Sets the channel to apply the BEAT FX and SEND/RETURN to.

41 TIME control (page 12)

Adjusts the BEAT FX time parameter.

42 LEVEL/DEPTH control (page 12)

Adjusts the BEAT FX quantitative parameter.

43 Beat effect ON/OFF button (page 12)

Turns BEAT FX on and off.

Do not pull on the channel fader and crossfader knobs with excessive force. The knobs have a structure by which they cannot be pulled off easily. Pulling the knobs strongly may result in damaging the unit.

Connections

Turn off this unit and disconnect the power cord from the power outlet before connecting components or changing the connections.
Connect the power cord to a power outlet after all the connections are completed.
Use the power cord supplied with this unit.
Refer to the operating instructions for the components to be connected.

- Use the USB cable supplied with this unit when connecting this unit to a computer.
- A USB hub cannot be used.

Connecting input terminals

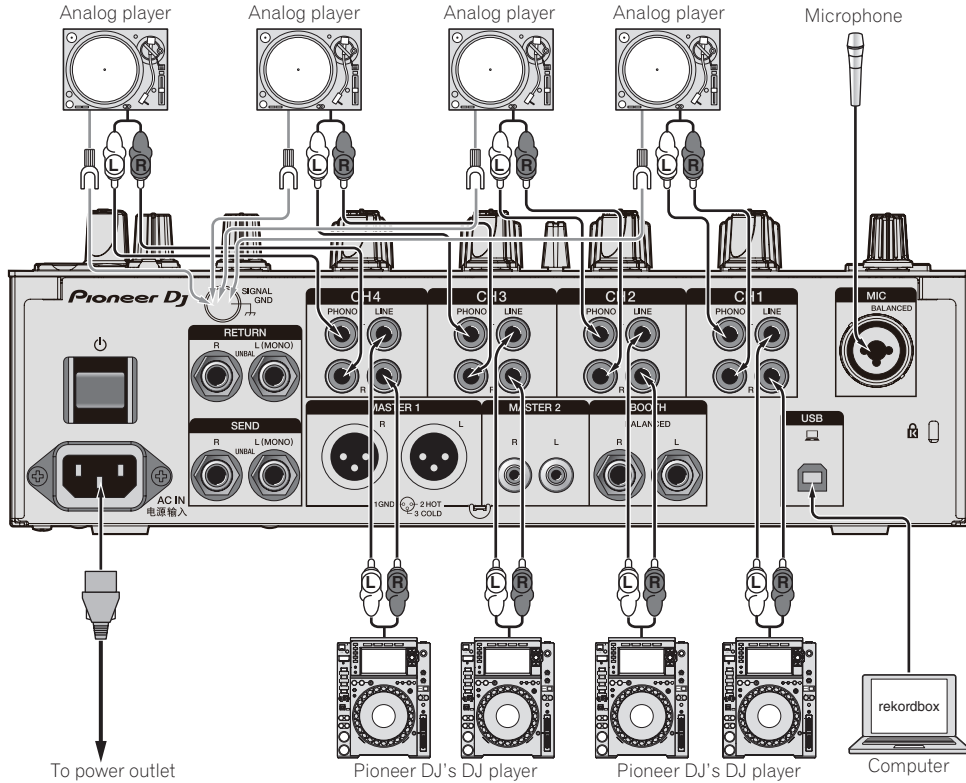

Connecting output terminals

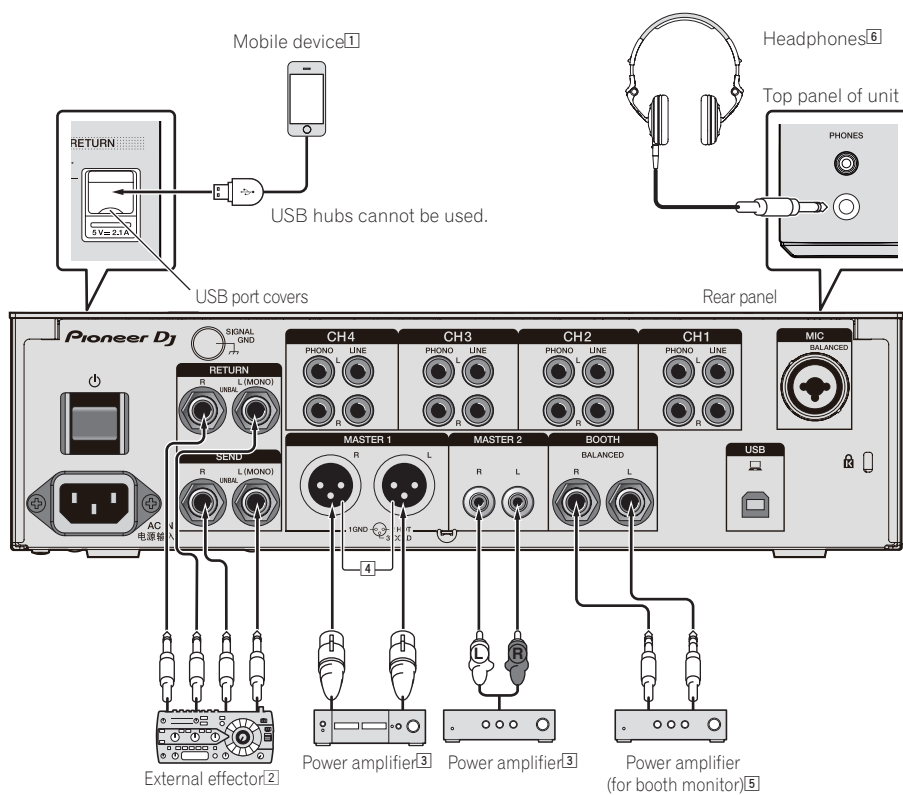

- 1 Connect an external effector to the [RETURN] terminal (input terminal).
- 2 Be sure to use the [MASTER1] terminals for a balanced output. If they are connected to an unbalanced input (such as RCA) with an XLR to RCA converter cable (or converter adapter), etc., the sound quality may be lowered or noise may occur. Use the [MASTER2] terminals for an unbalanced input (such as RCA).
- 3 **Be careful not to accidentally insert the power cord of another unit to [MASTER1] terminal. Do not connect the terminal that can supply phantom power to the [MASTER1] terminal.**
- 4 Be sure to use the [BOOTH] terminals for a balanced output. If they are connected to an unbalanced input (such as an RCA or TS input) with an TRS to RCA converter cable (or converter adapter), TS cable, etc., the sound quality may be lowered or noise may occur.

Connecting to the control panel

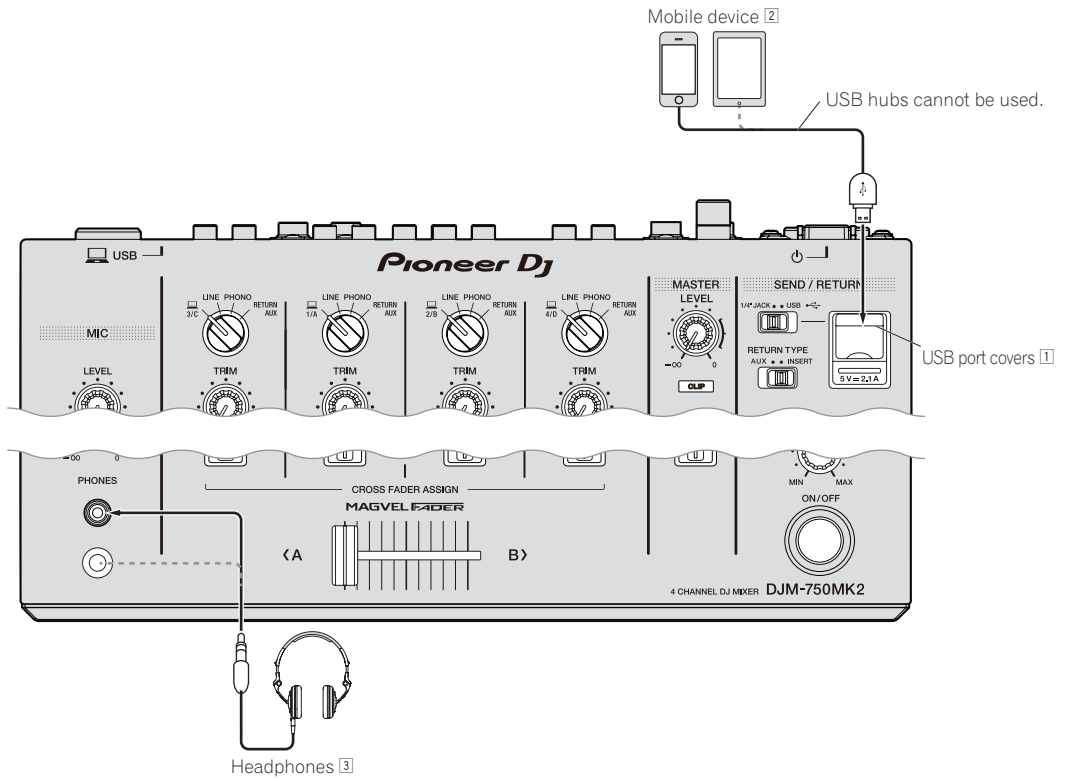

1 Do not push or pull hard on the USB port cover. It could be damaged.

2 When connecting a mobile device, use the cable supplied with the device.
For information on supported mobile devices, access the following Pioneer DJ site below.
pioneerdj.com/support/

3 Connect headphones to either the phone jack or the mini jack. If both jacks are used at the same time, the sound quality and volume may be lowered.

Operation

Basic Operation

Outputting sound

1 Press the [⏻] button.

This unit turns on.

2 Set the input selector switches.

Select an input source for each channel from the components connected to this unit.

- [USB]: Selects the computer connected to the [USB] terminal as an input source.
- [LINE]: Selects the device connected to the [LINE] terminals as an input source.
- [PHONO]: Selects the analog player connected to the [PHONO] terminals as an input source.
- [RETURN AUX]: Selects the [RETURN] sound for [SEND/RETURN].

When using [RETURN AUX], selects [AUX] for [RETURN TYPE] in [SEND/RETURN].

When using [SEND/RETURN], refer to *Using the SEND/RETURN function* on page 12.

3 Turn the [TRIM] control.

Adjusts the level of sound input to each channel.

The channel level indicator lights when audio signals are properly input to the channel.

4 Move the channel fader up.

Adjusts the level of sound output from each channel.

5 Set the [CROSS FADER ASSIGN (A, THRU, B)] selector switch.

Set the output destination of each channel.

- [A]: Outputs to [A] (left) of the crossfader.
- [B]: Outputs to [B] (right) of the crossfader.
- [THRU]: Select when not using the crossfader. The signals do not pass through the crossfader.

6 Set the crossfader.

Skip this operation when the [CROSS FADER ASSIGN (A, THRU, B)] selector switch is set to [THRU].

7 Turn the [MASTER LEVEL] control.

Audio signals are output from the [MASTER1] and [MASTER2] terminals.

The master level indicator lights.

Adjusting the sound quality

1 Set the [EQ CURVE (ISOLATOR, EQ)] selector switch.

- [ISOLATOR]: Adjusts the isolator settings.
- [EQ]: Adjusts the equalizer settings.

2 Turn the [EQ/ISO (HI, MID, LOW)] controls for each channel.

The adjustable ranges for each control are as follows.

- [HI]: -26 dB to +6 dB (20 kHz)
- [MID]: -26 dB to +6 dB (1 kHz)
- [LOW]: -26 dB to +6 dB (20 Hz)

Monitoring sound with headphones

1 Connect headphones to the [PHONES] terminal.

2 Press the [CUE] button of the channel to be monitored.

3 Set the [MONO SPLIT, STEREO] selector switch.

- [MONO SPLIT]: Outputs the sound of the channel selected with the [CUE] button to [L] and the sound of MASTER to R.
- [STEREO]: Outputs the sound of the channel for which the [CUE] button is pressed in stereo from the headphones.

4 Turn the [HEADPHONES MIXING] control.

Adjust the balance of the volume between the channel selected with the [CUE] button and MASTER.

5 Turn the [LEVEL] control for [HEADPHONES].

Adjust the volume of the headphones.

Switching the fader curve

❖ Selecting the channel fader curve characteristics

Select a channel fader curve type with the [CH FADER (▲, ▴, ▽)] selector switch.

- [▲]: Dramatically increases the volume when the channel fader is moved to the far side of the slider.
- [▴]: Gradually increases the volume as the channel fader is moved away from the near side of the slider.
- [▽]: Dramatically increases the volume when the channel fader is moved away from the near side of the slider.

❖ Selecting the crossfader curve characteristics

Switch the [CROSS FADER (∩, ∪, ×)] selector switch.

- [∩]: Creates a sharply increasing curve (if the crossfader is moved away from the [A] side, audio signals are immediately output from the [B] side).
- [∪]: Creates a curve shaped between the two curves above and below.
- [×]: Creates a gradually increasing curve (if the crossfader is moved away from the [A] side, the sound on the [B] side gradually increases, while the sound on the [A] gradually decreases).

Using a microphone

- 1 Connect a microphone to the [MIC] terminal.
- 2 Set the [OFF, ON, TALK OVER] selector switch to [ON] or [TALK OVER].
 - [ON]: The indicator lights.
 - [TALK OVER]: The indicator flashes.
- When set to [TALK OVER], the sound of channels other than the [MIC] channel is attenuated by 18 dB (default) if a sound of -10 dB or greater is input to the microphone.
- The [TALK OVER] sound attenuation level can be changed at [UTILITY]. For instructions on changing this, see *Changing the settings* on page 22.
- Talk over mode features normal and advanced mode (the default setting), which can be switched between at will. For details on switching between modes, see *Changing the settings* on page 22.

3 Turn the [MIC LEVEL] control to adjust the sound level of the microphone.

Adjusts the level of sound input from [MIC] channel.

- Note that the sound is output at a loud volume if the control is rotated to the extreme right.

4 Input audio to the microphone.

❖ Adjusting the sound quality

Turn the [EQ (HI, LOW)] controls of the [MIC] channels.

The adjustable ranges for each control are as follows.

- [HI]: -12 dB to +12 dB (10 kHz)
- [LOW]: -12 dB to +12 dB (100 Hz)

Outputting sound from the [BOOTH] terminals

Turn the [BOOTH MONITOR] control.

Adjusts the level of sound output from the [BOOTH] terminal.

Advanced Operations

Using the SOUND COLOR FX function

These are effects that change in association with the [COLOR] control.

1 Press one of the [SOUND COLOR FX] selection buttons.

This selects the type of effect.

The button that was pressed flashes.

- Even if one of the [SOUND COLOR FX] selection buttons is already selected, when a different button is selected and pressed, that button is selected.
- For the types of effects, see *Types of SOUND COLOR FX effects* on page 14.
- The same effects are set in [CH1] and [CH4].

2 Turn the [COLOR] control.

The effect is applied to the channel for which the control is turned.

The effect's quantitative parameter can be adjusted by turning the [PARAMETER] control.

❖ Canceling the SOUND COLOR FX effect

Press the [SOUND COLOR FX] selection button that is flashing.

The effect is canceled.

Using the BEAT FX function

This function enables instantaneously setting various effects according to the tempo (BPM = Beats Per Minute) of the track currently playing.

Main display

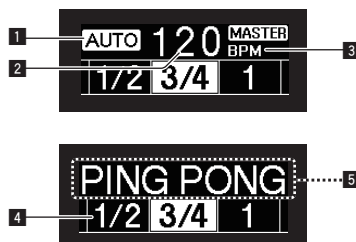

1	AUTO (TAP)	[AUTO] lights up when the BPM measurement mode is set to auto mode. [TAP] lights up when in manual input mode.
2	BPM value display (3 digits)	When in auto mode, the automatically detected BPM value is displayed. When the BPM cannot be detected, the previously detected BPM value is displayed and flashes. When in the manual input mode, this displays the BPM value that was input manually.
3	BPM	This is always lit. This section lights up according to the selected beat number position.
4	Beat/parameter display section	Depending on the effect, parameters are displayed when the [BEAT ◀, ▶] buttons are pressed. This section blinks when outside the parameter limits.
5	Effect name/Effect channel selection display	The name of the effect selected and the effect channel are displayed for a second when changing effects or effect channels.

1 Press the [AUTO/TAP] button.

Select the BPM measurement mode.

- [AUTO]: The BPM is measured automatically from the audio signal that is being input. [AUTO] mode is set when this unit is turned on.
- [TAP]: Enter the BPM manually. For instructions on input methods, see *Inputting the BPM manually* on page 12.

- The [AUTO] BPM measurement range is BPM = 70 to 180. For some tracks, it may not be possible to measure the BPM correctly. If the BPM cannot be measured, the BPM value on the display flashes. In such cases, use the [TAP] button to input the BPM manually.

2 Turn the beat effect selector switch.

This selects the type of effect.

- For the types of effects, see *Types of BEAT FX* on page 14.

3 Turn the effect channel selector switch.

This selects the channel to which the effect is applied.

The [BEAT FX] indicator for the channel selected with the effect channel selector lights up.

- [1] – [4]: The effect is applied to the sound of the respective channel.
- [MIC]: The effect is applied to the sound of [MIC] channel.
- [CROSS FADER A], [CROSS FADER B]: The effect is applied to the sound of the [A] (left) side or [B] side of the crossfader.
- [MASTER]: The effect is applied to the sound of the [MASTER] channel.

4 Press the [BEAT ◀, ▶] button.

Sets the beat fraction for synchronizing the effect sound.

The effect time corresponding to the beat fraction is set automatically.

5 Press the [FX FREQUENCY], [HI], [MID], or [LOW] button.

The range to which the effect is applied can be selected. When an effect is turned on, the button lights up and the effect is applied to the selected range. When an effect is turned off, the button turns off and the effect is not applied to the selected range.

6 Press the [ON/OFF] button for [BEAT FX].

The effect is applied to the sound.

The effect's time parameter can be adjusted by turning the [TIME] control.

The effect's quantitative parameter can be adjusted by turning the [LEVEL/DEPTH] control.

The [ON/OFF] button flashes when the effect is on.

- When the [ON/OFF] button is pressed again, the effect turns off.

❖ Inputting the BPM manually

Tap the [TAP] button at least 2 times in rhythm with the beat (in quarter notes) of the sound being played.

The average value of the interval at which the [TAP] button was tapped is set as the BPM.

- When the BPM is set using the [TAP] button, the beat fraction is set to [1/1] and the time of one beat (quarter note) is set as the effect time.
- The BPM can be set manually by turning the [TIME] control while pressing the [TAP] button.
- The BPM can be set in units of 0.1 by pressing the [AUTO/TAP] button while pressing the [TAP] button and turning the [TIME] control while pressing the two buttons.

Using the SEND/RETURN function

External effector and mobile devices can be used.

1 Connect this unit to an external effector.

For details on connections, see *Connecting output terminals* on page 8.

2 Switch the [SEND/RETURN] selector switches.

Select the effector to use.

- [1/4" JACK]: Select when using an external effector.
- [USB]: Select when using a mobile device.

3 Switch the [RETURN TYPE] selector switch.

Select the SEND/RETURN method.

- [AUX]: The audio of the channel selected in the effects channel is input to the external effector (or mobile device), and the output from the external effector (or mobile device) is input into the channel selected with [RETURN AUX] using the input selector switch.

Original sounds and effect sounds can be mixed together as desired.

Use the [SEND/RETURN LEVEL] control to adjust SEND LEVEL (the volume of vocals sent to external effectors or mobile devices).

Effect channel selector switch (SEND CH) →

[SEND/RETURN LEVEL] control (SEND LEVEL) ⇔ (SEND)

⇔ External effector or mobile device ⇔ (RETURN) ⇔

[SEND/RETURN ON/OFF] button → (Return [RETURN AUX] to the selected channel) → [TRIM] control

Returns to the channel for which RETURN AUX is selected. [SEND/RETURN ON/OFF] button

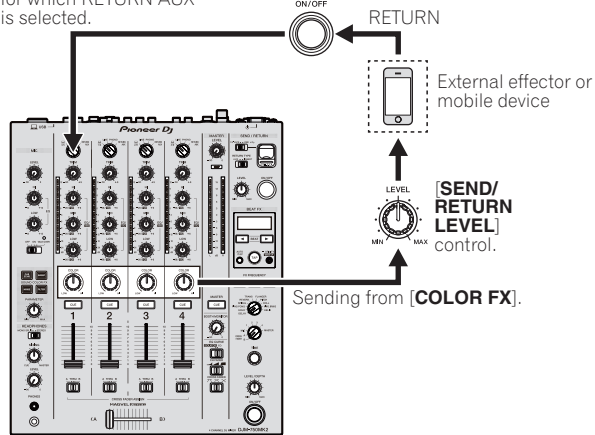

- [INSERT]: The audio of the channel selected in the effects channel is input to the external effector (or mobile device), and the output from the external effector (or mobile device) is input into the channel selected in effect channel. Use the [SEND/RETURN LEVEL] control to adjust RETURN LEVEL (the volume of vocals received from external effectors or mobile devices).

This function is the same as the SEND/RETURN function provided for the same system of the previous DJM series.

Effect channel selector switch (SEND CH) ⇔ (SEND)

⇔ External effector or mobile device ⇔ (RETURN) ⇔

[SEND/RETURN LEVEL] control (RETURN LEVEL) →

[SEND/RETURN ON/OFF] button → (Return to the same channel) → Channel fader

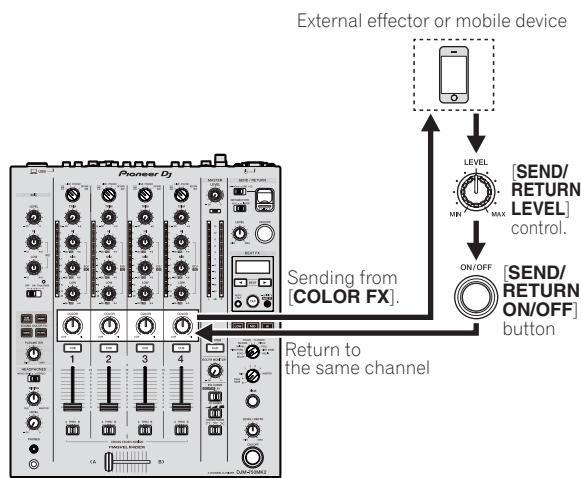

• For details, see *Block Diagram* on page 27.

4 Turn the effect channel selector switch.

Select the channel to apply the SEND/RETURN function to.

- The SEND/RETURN function is applied to the same channel to which the BEAT FX function is applied.

5 Press the [ON/OFF] button for [SEND/RETURN].

- When the [ON/OFF] button is pressed again, the SEND/RETURN function turns off.

6 Turn the [LEVEL] control for [SEND/RETURN].

Adjusts the SEND/RETURN sound level.

In the following cases, this function is forcibly disabled and the lit [ON/OFF] button of SEND/RETURN turns off.

- When the DJM-900NXS2 is not connected to an effector
- When the [RETURN TYPE] selector switch is set to [AUX], and the effect channel is set to [1], [2], [3], or [4], and the effect channel input selector switch is set to [RETURN AUX]
- When the [RETURN TYPE] selector switch is set to [AUX], and the effect channel is set to [CROSS FADER A], or [CROSS FADER B], and one or more of the channels assigned using the [CROSS FADER ASSIGN] switch is set to [RETURN AUX]
- When the [RETURN TYPE] selector switch is set to [AUX], and the effect channel is set to [MASTER]

Operating software using the MIDI interface

This unit outputs the operation information of buttons and controls in universal MIDI format.

When connected by USB cable to a computer or mobile device on which a MIDI-compatible software is installed, the software can be operated from this unit.

Install the software on your computer or mobile device before use. Also, set the software's audio and MIDI related settings.

- For MIDI channel setting instructions, see *Changing the settings* on page 22.
- For details of the MIDI messages on this unit, access the following Pioneer DJ support site.
pioneerdj.com/support/

● Connect this unit to a computer or mobile device.

- Computer: Connect your computer to the [USB] terminal using a USB cable.
- Mobile device: Connect the mobile device to the mobile device connection terminal using a USB cable.

For details on connections, see *Connecting to the control panel* on page 9.

After connection, MIDI message send starts.

- MIDI time clock is send constantly.
- Moving a fader or control sends a message corresponding to its position.

Types of effects

Types of SOUND COLOR FX effects

Effect name	Descriptions	[COLOR] control	[PARAMETER] control
DUB ECHO	Applies an echo effect, with the sound delayed slightly after the original sound output several times and gradually attenuated.	Turn counterclockwise: Applies the echo effect to the mid-range only. Turn clockwise: Applies the echo effect to the high-range only.	Turning the control to the right increases feedback.
SWEEP	Turning the control to the left produces a gate effect, and turning it to the right produces a band pass filter effect.	Turn counterclockwise: Produces a gate effect making the sound tighter, with a reduced sense of volume. Turn to right: Steadily decreases the band pass filter bandwidth.	Turning the [COLOR] control to the left adjusts the gate effect. Turn to the right to tighten the sound. Turning the [COLOR] to the right adjusts the center frequency. Turn to the right to increase the center frequency.
NOISE	White noise generated inside this unit is mixed in to the sound of the channel via the filter and output.	Turn counterclockwise: Gradually decreases the cut-off frequency of the filter through which the white noise passes. Turn clockwise: Gradually increases the cut-off frequency of the filter through which the white noise passes.	Turn to the right to increase white noise volume. • The sound quality can be adjusted by turning the [EQ/ISO (HI, MID, LOW)] control.
FILTER	Outputs sound that has passed through a filter.	Turn counterclockwise: Gradually decreases the low-pass filter's cut-off frequency. Turn clockwise: Gradually increases the high-pass filter's cut-off frequency.	Turn to the right to increase resonance.

Types of BEAT FX

DELAY¹⁾

A delayed sound is output once according to the beat fraction set with the [BEAT ◀, ▶] buttons.

- Lowering the channel faders and cutting the input volume leaves a delayed sound.

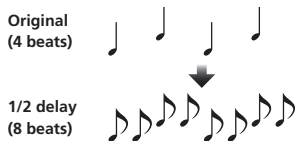

BEAT ◀, ▶ buttons (parameter 1)	Sets the delay time between 1/16 and 16 beats with respect to 1 beat of BPM time.
TIME control (parameter 2)	Sets the delay time. 1 to 4000 (ms)
LEVEL/DEPTH control (parameter 3)	Sets the balance between the original sound and the delayed sound.

ECHO¹⁾

A delayed sound is output several times and gradually attenuated according to the beat fraction set with the [BEAT ◀, ▶] buttons.

- Lowering the channel faders and cutting the input volume leaves an echo sound, producing a fade out.

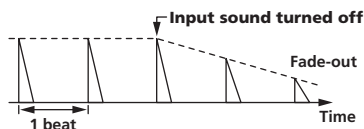

BEAT ◀, ▶ buttons (parameter 1)	Sets the delay time between 1/16 and 16 beats with respect to 1 beat of BPM time.
TIME control (parameter 2)	Sets the delay time. 1 to 4000 (ms)
LEVEL/DEPTH control (parameter 3)	Sets the balance between the original sound and the echo sound.

PING PONG¹⁾

Outputs multiple times while the delayed sound is attenuated with different delay timing to the left and right speakers, in sync with the scaled beat set with the [BEAT ◀, ▶] buttons, producing a stereo effect.

- Lowering the channel faders and cutting the input volume leaves an echo sound, producing a fade out.

BEAT ◀, ▶ buttons (parameter 1)	Sets the delay time between 1/16 and 16 beats with respect to 1 beat of BPM time.
TIME control (parameter 2)	Sets the delay time. 10 to 4000 (ms)
LEVEL/DEPTH control (parameter 3)	Sets the balance between the original sound and the echo sound.

SPIRAL¹⁾

This function adds a reverberation effect to the input sound.

When the delay time is changed, the pitch changes simultaneously.

- Lowering the channel faders and cutting the input volume leaves an effect sound.

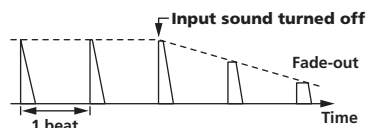

BEAT ◀, ▶ buttons (parameter 1)	Sets the delay time between 1/16 and 16 beats with respect to 1 beat of BPM time.
TIME control (parameter 2)	Sets the delay time. 10 to 4000 (ms)
LEVEL/DEPTH control (parameter 3)	Sets feedback, and the balance between the original sound and the effect sound.

REVERB

This function adds a reverberation effect to the input sound.

- Lowering the channel faders and cutting the input volume leaves a delay sound.

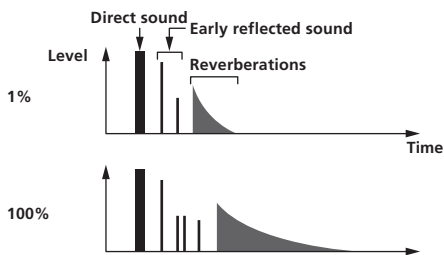

BEAT ◀, ▶ buttons (parameter 1)	Sets the extent of the reverberation effect, from 1 – 100 % .
TIME control (parameter 2)	Use this to set the degree of the reverb effect. 1 – 100 (%)
LEVEL/DEPTH control (parameter 3)	Sets the balance between the original sound and the effect sound.

TRANS

The sound is cut according to the beat fraction set with the [BEAT ◀, ▶] buttons.

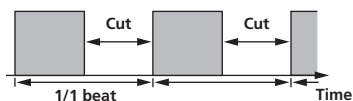

BEAT ◀, ▶ buttons (parameter 1)	Sets the beat fraction between 1/16 and 16 with respect to 1 beat of BPM time.
TIME control (parameter 2)	Sets the effect time. 10 to 16000 (ms)
LEVEL/DEPTH control (parameter 3)	Sets the duty ratio and balance between the original sound and effect sound.

FLANGER

A 1-cycle flanger effect is produced according to the beat fraction set with the [BEAT ◀, ▶] buttons.

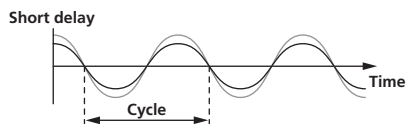

BEAT ◀, ▶ buttons (parameter 1)	Sets the effect time between 1/16 and 64 beats with respect to 1 beat of BPM time.
TIME control (parameter 2)	Use this to set the cycle by which the flanger effect moves. 10 to 32000 (ms)
LEVEL/DEPTH control (parameter 3)	The further the control is turned clockwise, the more the effect is stressed. When turned all the way counterclockwise, only the original sound is output.

PITCH

Changes the pitch of the source sound.

BEAT ◀, ▶ buttons (parameter 1)	Sets the pitch of the effect sound. -50 to 100 (%)
TIME control (parameter 2)	Sets the pitch of the effect sound. -50 to 100 (%)
LEVEL/DEPTH control (parameter 3)	Sets the pitch of the effect sound. Turn fully left to return to the original sound.

ROLL

The sound being input at the point when the [ON/OFF] button is pressed is recorded, and the recorded sound is output repeatedly according to the beat fraction set with the [BEAT ◀, ▶] buttons.

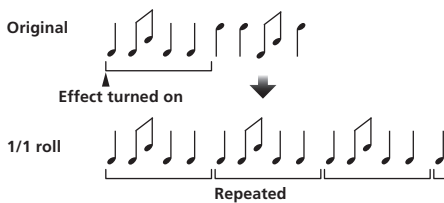

BEAT ◀, ▶ buttons (parameter 1)	Sets the effect time between 1/16 and 16 beats with respect to 1 beat of BPM time.
TIME control (parameter 2)	Sets the effect time. 10 to 4000 (ms)
LEVEL/DEPTH control (parameter 3)	Sets the balance between the original sound and ROLL .

VINYL BRAKE

The playback speed of the input sound changes according to the beat fraction set with the [BEAT ◀, ▶] buttons, slowing steadily, until playback stops.

BEAT ◀, ▶ buttons (parameter 1)	Sets the effect time between 1/16 and 16 beats with respect to 1 beat of BPM time.
TIME control (parameter 2)	Sets the effect time. 10 to 4000 (ms)
LEVEL/DEPTH control (parameter 3)	Sets the playback speed of the input sound. Turn fully left to return steadily to the original sound. Turn right from the fully left position to slow playback steadily, resulting in an effect that stops playback.

HELIX

The sound being input at the point when the [ON/OFF] button is pressed is recorded, and the recorded sound is output repeatedly according to the beat fraction set with the [BEAT ◀, ▶] buttons.

Turn the [LEVEL/DEPTH] control right from the fully left position to record the input sound. Also, turning it fully right fixes the output sound. Altering the effect time changes the pitch of the sound recorded up to that point.

BEAT ◀, ▶ buttons (parameter 1)	Sets the effect time between 1/16 and 16 beats with respect to 1 beat of BPM time.
TIME control (parameter 2)	Sets the effect time. 10 to 4000 (ms)
LEVEL/DEPTH control (parameter 3)	Sets the ratio of sound overlay. Turn fully left to return to the original sound. Turn right from the fully left position to record the input sound in its default state

- ⓘ When [1] to [4] is selected with the effect channel selector switch, the effect sound cannot be monitored even if the [CUE] button of the selected channel is pressed.

Use rekordbox dj

rekordbox

This manual mainly explains the hardware operations of this unit. For detailed instructions on operating rekordbox dj and rekordbox dvs, see the rekordbox manual.

- **rekordbox**
rekordbox is composite software that enables track management and DJ performances.
- **rekordbox dj**
The DJ performance function of rekordbox is called rekordbox dj. To be able to use this function, enter the license key shown on the license key card included with this unit.
- **rekordbox dvs**
A function that can be added to rekordbox dj, with a DVS function that operates the deck in response to control signals played with a CDJ or turntable, called rekordbox dvs. Enter the license key written on the license key card included with the product to add this function to rekordbox dj.

Required operating environment

Supported operating systems	CPU and required memory
Mac: macOS Sierra 10.12, OS X 10.11/10.10/10.9 (latest update)	Intel® processor Core™ i3/i5/i7, Intel® processor Core™ 2 Duo 2.0 GHz or higher. 4 GB or more of RAM
Windows® 10/ Windows® 8.1/Windows® 7 (latest service pack)	Intel® processor Core™ i3/i5/i7, Intel® processor Core™ 2 Duo 2.0 GHz or higher. 4 GB or more of RAM
Others	
USB port	A USB 2.0 port is required to connect a computer to this unit.
Display resolution	1280 x 768 or higher resolution
Internet connection	An Internet connection is required for registering the rekordbox user account and downloading the software.

- For information on the latest system requirements, compatibility, and supported operating systems of rekordbox, see [System Requirements] on the following rekordbox product site.
rekordbox.com
- Operation on all computers is not guaranteed even if the computers meet the required operating environment.
- The CPU and hard disc may not provide sufficient processing capabilities depending on the power-saving setting, etc. on the computer. Confirm that the computer meets conditions to provide constant high-performance (for example, connecting the computer to a power outlet to maintain a stable power supply) especially when using rekordbox on a laptop.
- A separate contract with an internet service provider and payment of the utilization fee are required to access the internet.
- The Operating System support assumes that the latest version is used.

Viewing the Operating Instructions of rekordbox

Some operating instructions are provided in PDF files. Adobe® Reader® is required to view the PDF files.

1 Launch a web browser on the computer and access the following rekordbox product site below.

rekordbox.com

2 Click [Support].

3 Click [Manual].

4 Click a language of the manual.

Download as necessary.

- For details on obtaining rekordbox, access the rekordbox product site indicated above.

Installing rekordbox

If you are installing rekordbox for the first time or are upgrading from rekordbox 3 or earlier, use the following procedures. If you have installed rekordbox 4 already, update it to the latest version.

Before installing rekordbox

The rekordbox software is not included.

Access the following rekordbox product site and download the software.

rekordbox.com

- The user is responsible for preparing the computer, network devices, and other elements of the Internet usage environment required for a connection to the Internet.
- If you have installed rekordbox 4 already, update it to the latest version to use rekordbox dj and rekordbox dvs.

Obtaining the rekordbox software

1 Access the following rekordbox product site.

rekordbox.com/ja/store/

- The page content is subject to change without notice.

2 Check the get Started Guide and then click [Free To Download].



3 Carefully read the Software End User License Agreement and select the [Agree] check box if you agree.

When you select the check box, [Download] becomes clickable.

4 Click [Download].

Downloading of rekordbox starts.

Installing the rekordbox software

The installation procedure depends of the operating system (OS) of the computer you are using.

- Do not connect this unit and the computer until the installation is completed.
- Close all the applications running on the computer before installation.

❖ Installation procedure (Mac OS X)

- 1 Unzip the downloaded rekordbox software file.
- 2 Double-click the rekordbox software to launch the installer.
- 3 Read the license agreement, and select **[Agree]** if you agree to the terms.

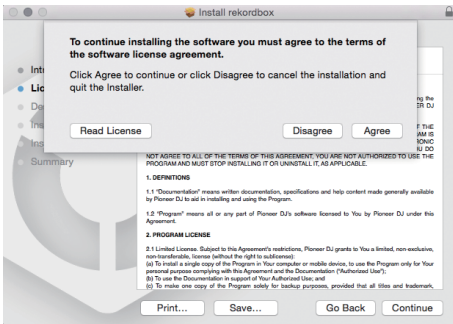

- If you do not agree to the contents of the license agreement, click **[Disagree]** to cancel the installation.

- 4 When the installation completion screen appears, click **[Close]** to close the rekordbox installer.

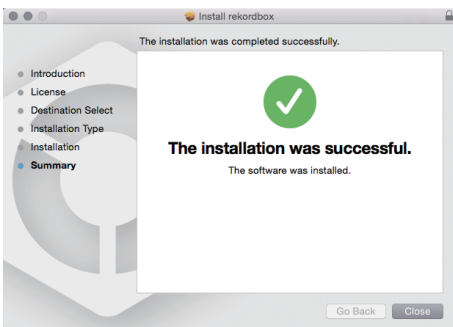

❖ Installation (for Windows)

Log in to the computer as the administrator before installation.

- 1 Unzip the downloaded rekordbox software file.
- 2 Double-click the rekordbox software to launch the installer.
- 3 Read the license agreement, select **[I agree to the license terms and conditions]** if you agree to the terms, and click **[Next]**.

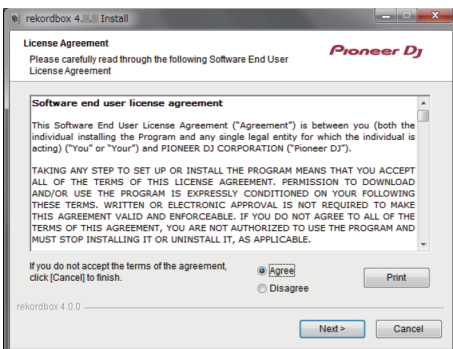

- If you do not agree to the contents of the license agreement, click **[Cancel]** to quit installation. After the installation destination is specified, the installation starts. When the installation is completed, an installation successful message appears.

- 4 Click **[Close]** to close the rekordbox installer.

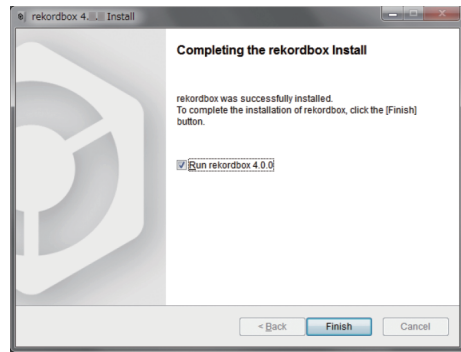

Launch rekordbox

Click the **[rekordbox]** icon.

For Mac OS X

Open the **[Applications]** folder in Finder and then double-click the **[rekordbox]** icon in the **[rekordbox 4]** folder.

For Windows 10/8.1

From **[Apps view]**, click the **[rekordbox]** icon.

For Windows 7

From the **[Start]** menu, click **[All Programs] > [Pioneer] > [rekordbox X.X.X] > the [rekordbox X.X.X] icon in order.**

Preparing rekordbox

- This procedure is required only when rekordbox is launched for the first time.

Enter the account information

If you already have an account, enter the account information and then click **[Setup]**.

If you do not have an account, click **[Create an account]** to go to the website for creating an account and then create an account.

- For details on the account creation procedure, access the following rekordbox product site below and see the rekordbox Operating Instructions in **[Support]**.
rekordbox.com

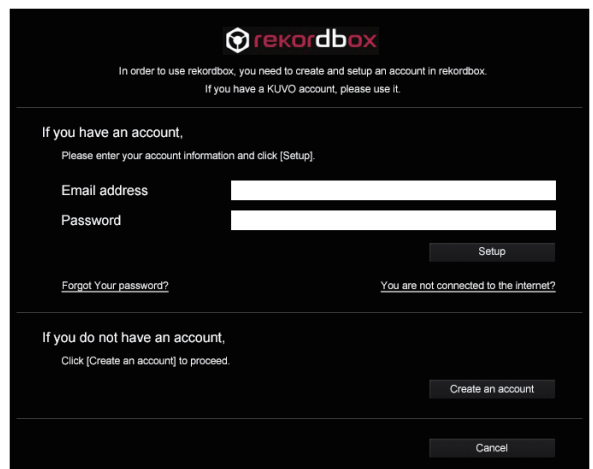

Select the usage method

Click the [DJ performance] icon.

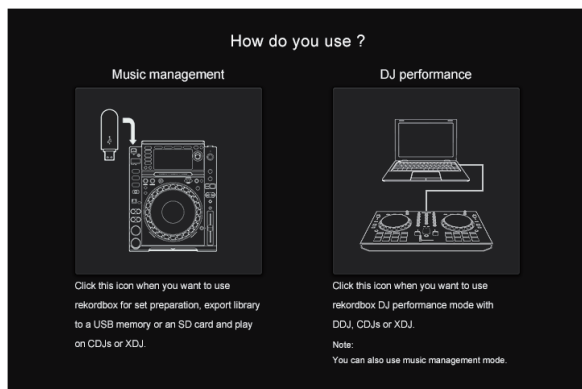

Enter the license key and activate the software

Enter the license key shown on the rekordbox dj license key card included with this unit and activate the software following the instructions on the screen.

- For details on the activation procedure, access the following rekordbox product site and see the rekordbox operating instructions in [Support].
rekordbox.com

Installing the driver software

The audio driver software is an exclusive driver for outputting audio signals from a computer from the unit.

- Disconnect the USB cable connecting this unit to the computer.
- Select [DJM-750MK2] from the pull-down menu and click [Install] in the audio driver installation screen.

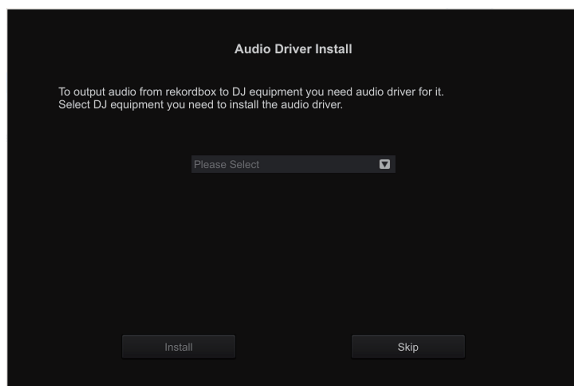

- If [Skip] is selected, the audio driver is not installed.

To install the audio drivers later, select one of the following from [Preference] > [Audio] > [Audio] > [Driver] on rekordbox dj, and install.

- For Mac OS X: DJM-750MK2_M_X.X.X.dmg
- For Windows: DJM-750MK2_X.XXX.exe

❖ Installation procedure (Mac OS X)

- Do not connect this unit and the computer until the installation is completed.
- Close all the applications running on the computer before installation.

- Check the details on the screen and click [Continue Anyway].
- When the end user license agreement appears, read the *Software end user license agreement* carefully, then click [Continue Anyway].
If you do not consent to the provisions of the *Software end user license agreement*, click [Disagree] and stop installation.
- Complete the installation by following the instructions on the screen.
- Connect this unit to your computer using a USB cable.

❖ Installation procedure (Windows)

- Do not connect this unit and the computer until the installation is completed.
- Log in to the computer as the administrator before installation.
- Close all the applications running on the computer before installation.

- Check the details on the screen and click [Continue Anyway].
- Carefully read the *Software end user license agreement* and if you consent to the provisions, put a check mark next to [I agree.] and click [OK].
If you do not consent to the provisions of the *Software end user license agreement*, click [Cancel] and stop installation.
- Complete the installation by following the instructions on the screen.
If [Windows Security] appears on the screen while the installation is in progress, click [Install this driver software anyway] to continue the installation.
When the installation is completed, a completion message appears.
- Connect this unit to your computer using a USB cable.

Adding track files to [Collection]

[Collection] is a screen for displaying a list of the track files managed by rekordbox.

Registering the track files on the computer as the collection of music for rekordbox and then analyzing them enables those tracks to be used with rekordbox.

- Click [Collection] in the tree view.
A list of the tracks registered in [Collection] is displayed.
- Open Finder or Windows Explorer, then drag and drop track files or folders containing track files to the track list.
The track files are added to [Collection], and the waveform information analysis of the track files starts. Wait until the analysis of all the track files is finished.

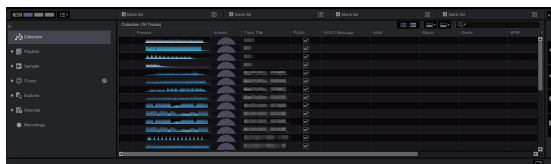

Using the DVS

Digital music files on a computer can be played by connecting the computer ^[1] and an analog player (or DJ player) to this unit and then playing a control disc ^[2] on the analog player (or DJ player).

[1] Install rekordbox dj on your computer beforehand.

[2] A special record or CD containing the signals necessary for operating digital music files.

The settings of rekordbox dj

For details on the settings of rekordbox for using DVS, see "rekordbox dvs Setup Guide" on the following website.
rekordbox.com/ja/support/manual.php

Setting the control signals

Set the control signals according to whether your device is an analog player or DJ player.

Set the control signals as described below.

1 Connect this unit to the computer with a USB cable.

2 Launch rekordbox.

3 Click [Preferences] > [Input channel] > [Settings Utility] of rekordbox (PERFORMANCE mode).

The setting utility of this unit starts.

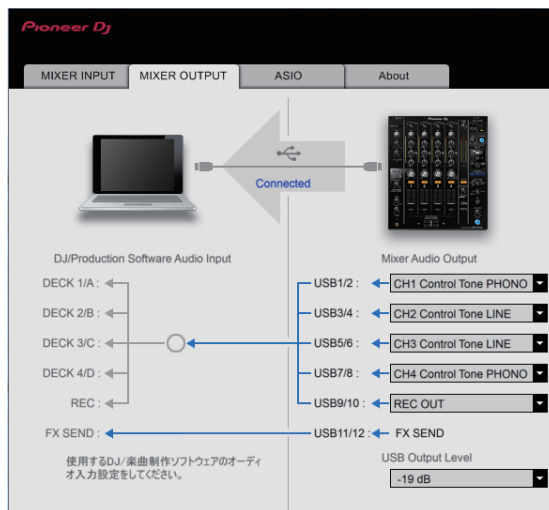

4 Select the [MIXER OUTPUT] tab in the setting utility and then select as shown below from the [Mixer Audio Output] pull-down menu that corresponds to the connected channel.

For an analog player: [CH* Control Tone PHONO]

For DJ players: [CH* Control Tone LINE]

Using applications other than rekordbox dj

Installing the driver software

This driver software is a proprietary program for inputting and outputting audio signals from a computer. To use this unit while connected to a computer on which a Windows or Mac OS is installed, install the driver software on the computer beforehand.

Software end user license agreement

This Software End User License Agreement ("Agreement") is between you (both the individual installing the Program and any single legal entity for which the individual is acting) ("You" or "Your") and Pioneer DJ Corporation ("Pioneer DJ").

TAKING ANY STEP TO SET UP OR INSTALL THE PROGRAM MEANS THAT YOU ACCEPT ALL OF THE TERMS OF THIS LICENSE AGREEMENT. PERMISSION TO DOWNLOAD AND/OR USE THE PROGRAM IS EXPRESSLY CONDITIONED ON YOUR FOLLOWING THESE TERMS. WRITTEN OR ELECTRONIC APPROVAL IS NOT REQUIRED TO MAKE THIS AGREEMENT VALID AND ENFORCEABLE. IF YOU DO NOT AGREE TO ALL OF THE TERMS OF THIS AGREEMENT, YOU ARE NOT AUTHORIZED TO USE THE PROGRAM AND MUST STOP INSTALLING IT OR UNINSTALL IT, AS APPLICABLE.

1 DEFINITIONS

- 1 "Documentation" means written documentation, specifications and help content made generally available by Pioneer DJ to aid in installing and using the Program.
- 2 "Program" means all or any part of Pioneer DJ's software licensed to You by Pioneer DJ under this Agreement.

2 PROGRAM LICENSE

- 1 Limited License. Subject to this Agreement's restrictions, Pioneer DJ grants to You a limited, non-exclusive, non-transferable, license (without the right to sublicense):
 - a To install a single copy of the Program in Your computer or mobile device, to use the Program only for Your personal purpose complying with this Agreement and the Documentation ("Authorized Use");
 - b To use the Documentation in support of Your Authorized Use; and
 - c To make one copy of the Program solely for backup purposes, provided that all titles and trademark, copyright and restricted rights notices are reproduced on the copy.
- 2 Restrictions. You will not copy or use the Program or Documentation except as expressly permitted by this Agreement. You will not transfer, sublicense, rent, lease or lend the Program, or use it for third-party training, commercial time-sharing or service bureau use. You will not Yourself or through any third party modify, reverse engineer, disassemble or decompile the Program, except to the extent expressly permitted by applicable law, and then only after You have notified Pioneer DJ in writing of Your intended activities.
- 3 Ownership. Pioneer DJ or its licensor retains all right, title and interest in and to all patent, copyright, trademark, trade secret and other intellectual property rights in the Program and Documentation, and any derivative works thereof. You do not acquire any other rights, express or implied, beyond the limited license set forth in this Agreement.
- 4 No Support. Pioneer DJ has no obligation to provide support, maintenance, upgrades, modifications or new releases for the Program or Documentation under this Agreement.

3 WARRANTY DISCLAIMER

THE PROGRAM AND DOCUMENTATION ARE PROVIDED "AS IS" WITHOUT ANY REPRESENTATIONS OR WARRANTIES, AND YOU AGREE TO USE THEM AT YOUR SOLE RISK. TO THE FULLEST EXTENT PERMISSIBLE BY LAW, PIONEER DJ EXPRESSLY DISCLAIMS ALL WARRANTIES OF ANY KIND WITH RESPECT TO THE PROGRAM AND DOCUMENTATION, WHETHER EXPRESS, IMPLIED, STATUTORY,

OR ARISING OUT OF COURSE OF PERFORMANCE, COURSE OF DEALING OR USAGE OF TRADE, INCLUDING ANY WARRANTIES OF MERCHANTABILITY, FITNESS FOR A PARTICULAR PURPOSE, SATISFACTORY QUALITY, ACCURACY, TITLE OR NON-INFRINGEMENT.

4 EXPORT CONTROL AND COMPLIANCE WITH LAWS AND REGULATIONS

You may not use or otherwise export or re-export the Program except as authorized by United States law and the laws of the jurisdiction in which the Program was obtained. In particular, but without limitation, the Program may not be exported or re-exported (a) into any U.S.-embargoed countries or (b) to anyone on the U.S. Treasury Department's Specially Designated Nationals List or the U.S. Department of Commerce Denied Persons List or Entity List. By using the Program, you represent and warrant that you are not located in any such country or on any such list. You also agree that you will not use the Program for any purposes prohibited by United States law, including, without limitation, the development, design, manufacture, or production of nuclear, missile, or chemical or biological weapons.

5 U.S. GOVERNMENT RESTRICTED RIGHTS

The Program and Documentations are "commercial computer software" and "commercial computer software documentation" as those terms are defined in 48 C.F.R. §252.227-7014 (a) (1) (2007) and 252.227-7014 (a) (5) (2007). The U.S. Government's rights with respect to the Program and Documentations are limited by this license pursuant to 48 C.F.R. §12.212 (Computer software) (1995) and 48 C.F.R. §12.211 (Technical data) (1995) and/or 48 C.F.R. §227.7202-3, as applicable. As such, the Program and Documentations are being licensed to the U.S. Government end users: (a) only as "commercial items" as that term is defined in 48 C.F.R. §2.101 generally and as incorporated in DFAR 212.102; and (b) with only those limited rights as are granted to the public pursuant to this license. Under no circumstance will the U.S. Government or its end users be granted any greater rights than we grant to other users, as provided for in this license. Manufacturer is Pioneer DJ Corporation, 1-1 Shin-Ogura, Saiwai-ku, Kawasaki-shi, Kanagawa, 212-0031 Japan

6 DAMAGES AND REMEDIES FOR BREACH

You agree that any breach of this Agreement's restrictions would cause Pioneer DJ irreparable harm for which money damages alone would be inadequate. In addition to damages and any other remedies to which Pioneer DJ may be entitled, You agree that Pioneer DJ may seek injunctive relief to prevent the actual, threatened or continued breach of this Agreement.

7 TERMINATION

Pioneer DJ may terminate this Agreement at any time upon Your breach of any provision. If this Agreement is terminated, You will stop using the Program, permanently delete it from your computer or mobile device where it resides, and destroy all copies of the Program and Documentation in Your possession, confirming to Pioneer DJ in writing that You have done so. Sections 2.2, 2.3, 2.4, 3, 4, 5, 6, 7 and 8 will continue in effect after this Agreement's termination.

8 GENERAL TERMS

- 1 Limitation of Liability. In no event will Pioneer DJ or its subsidiaries be liable in connection with this Agreement or its subject matter, under any theory of liability, for any indirect, incidental, special, consequential or punitive damages, or damages for lost profits, revenue, business, savings, data, use, or cost of substitute procurement, even if advised of the possibility of such damages or if such damages are foreseeable. In no event will Pioneer DJ's liability for all damages exceed the amounts actually paid by You to Pioneer DJ or its subsidiaries for the Program. The parties acknowledge that the liability limits and risk allocation in this Agreement are reflected in the Program price and are essential elements of the bargain between the parties, without which Pioneer DJ would not have provided the Program or entered into this Agreement.

- 2 The limitations or exclusions of warranties and liability contained in this Agreement do not affect or prejudice Your statutory rights as consumer and shall apply to You only to the extent such limitations or exclusions are permitted under the laws of the jurisdiction where You are located.
- 3 Severability and Waiver. If any provision of this Agreement is held to be illegal, invalid or otherwise unenforceable, that provision will be enforced to the extent possible or, if incapable of enforcement, deemed to be severed and deleted from this Agreement, and the remainder will continue in full force and effect. The waiver by either party of any default or breach of this Agreement will not waive any other or subsequent default or breach.
- 4 No Assignment. You may not assign, sell, transfer, delegate or otherwise dispose of this Agreement or any rights or obligations under it, whether voluntarily or involuntarily, by operation of law or otherwise, without Pioneer DJ's prior written consent. Any purported assignment, transfer or delegation by You will be null and void. Subject to the foregoing, this Agreement will be binding upon and will inure to the benefit of the parties and their respective successors and assigns.
- 5 Entire Agreement. This Agreement constitutes the entire agreement between the parties and supersedes all prior or contemporaneous agreements or representations, whether written or oral, concerning its subject matter. This Agreement may not be modified or amended without Pioneer DJ's prior and express written consent, and no other act, document, usage or custom will be deemed to amend or modify this Agreement.
- 6 You agree that this Agreement shall be governed and construed by and under the laws of Japan.

Notes on installation

- Before installing the driver software, be sure to turn off the power of this unit and disconnect the USB cable from both this unit and your computer.
- If you connect this unit to your computer without installing the driver software first, an error may occur on your computer depending on the system environment.
- If you previously discontinued the installation process while it was in progress, perform the installation process again from the beginning according to the following procedure.
- Read the *Software end user license agreement* carefully before installing this unit's proprietary driver software.
- Before installing the driver software, terminate all other programs running on your computer.
- The driver software is compatible with the following operating systems.

Supported operating systems

MacOS Sierra 10.12 (latest update), Mac OS X 10.11, 10.10, 10.9 (latest update)	✓
Windows® 10 Home/10 Pro (Latest service pack)	32-bit version ✓
	64-bit version ✓
Windows® 8.1/8.1 Pro (latest service pack)	32-bit version ✓
	64-bit version ✓
Windows® 7 Home Premium/Professional/Ultimate (latest service pack)	32-bit version ✓
	64-bit version ✓

Checking the latest information on the driver software

For the latest information on this unit's dedicated driver software, access the following Pioneer DJ support site.
pioneerdj.com

Obtaining the driver software

- 1 Launch a web browser on a computer and access the following Pioneer DJ site.
pioneerdj.com
- 2 Click [Support].
- 3 Click [FIND SOFTWARE & FIRMWARE UPDATES].
- 4 Click [DJM-750MK2] in the [DJ MIXER] category.

5 After clicking [Drivers], download the latest driver software from the download page.

- Download the driver for either Windows or Mac from the download page.

Installing the driver software

The installation procedure depends of the operating system (OS) of the computer you are using.

- Do not connect this unit and the computer until the installation is completed.
- Close all the applications running on the computer before installation.

❖ Installation (for Windows)

Read *Notes on installation* carefully before installing the driver software.

- Log in as the user registered as the computer's administrator, and then install.

1 Double-click the file for Windows (DJM-750MK2_X.XXX.exe) downloaded in *Obtaining the driver software*.

The driver software installation screen appears.

2 Carefully read the *Software end user license agreement* and if you consent to the provisions, put a check mark next to [I agree.] and click [OK].

If you do not consent to the provisions of the *Software end user license agreement*, click [Cancel] and stop installation.

3 Complete the installation by following the instructions on the screen.

If [Windows Security] appears on the screen while the installation is in progress, click [Install this driver software anyway] to continue the installation.

- When the installation is completed, a completion message appears.

❖ Installation procedure (Mac OS X)

Read *Notes on installation* carefully before installing the driver software.

- To install or uninstall the driver software, you need to be authorized by the administrator of your computer. Have the name and password of the administrator of your computer ready in advance.

1 Double-click the file for Mac (DJM-750MK2_M_X.X.X.dmg) downloaded in *Obtaining the driver software*.

2 Double-click [DJM-750MK2_AudioDriver.pkg].

The driver software installation screen appears.

3 Check the details on the screen and click [Continue Anyway].

4 When the end user license agreement appears, read the *Software end user license agreement* carefully, then click [Continue Anyway].

5 If you consent to the provisions of the *Software end user license agreement*, click [Agree].

If you do not consent to the provisions of the *Software end user license agreement*, click [I disagree] and stop installation.

6 Complete the installation by following the instructions on the screen.

- To cancel the installation after it has started, click [Cancel].

Changing the settings

Setting preferences

*: Setting upon purchase

Options settings	Detail setting items	Setting value	Descriptions
MASTER OUT	PEAK LIMITER	OFF, ON*	Reduces sudden, unpleasant digital clipping of the master output.
	ATT.	-12 dB, -6 dB, 0 dB*	Sets the attenuation level of the sound output from the [MASTER1] and [MASTER2] terminals.
	MONO/STEREO	MONO, STEREO*	Sets monaural or stereo sound for master output.
BOOTH OUT	ATT.	-12 dB, -6 dB, 0 dB*	Sets the attenuation level of the sound output from the [BOOTH] terminal.
	MONO/STEREO	MONO, STEREO*	Sets monaural or stereo sound for booth output.
MIC OUT TO MASTER	PEAK LIMITER THRESHOLD LEVEL	0 dB, 3 dB, 6 dB, 9 dB, 12 dB, 15 dB, OFF*	Sets the microphone audio limiter to be applied to the master output.
MIC OUT TO BOOTH	LEVEL	OFF, -18 dB, -15 dB, -12 dB, -9 dB, -6 dB, -3 dB, 0 dB*	Sets the microphone audio level to be applied to the booth output.
	PEAK LIMITER THRESHOLD LEVEL	0 dB, 3 dB, 6 dB, 9 dB, 12 dB, 15 dB, OFF*	Sets the microphone audio limiter to be applied to the booth output.
MIC LOW CUT	—	OFF, ON*	Turns on/off the function that cuts the low frequencies of the microphone audio.
TALK OVER	MODE	ADVANCED*, NORMAL	Selects the talk over function's mode, [ADVANCED] or [NORMAL].
	LEVEL	-24 dB, -18 dB*, -12 dB, -6 dB	Sets the talk over function's sound attenuation level.
	CH	1* to 16	Sets the MIDI channel.
MIDI	BUTTON TYPE	TOGGLE*, TRIGGER	Selects the MIDI signal transmission mode, [TOGGLE] or [TRIGGER].
OLED BRIGHTNESS	—	1 to 3*	Sets the main unit display's brightness.
PC UTILITY	—	OFF*, ON	Sets whether or not to launch the computer's setting utility software automatically when a USB cable is connected.
AUTO STANDBY	—	OFF, ON*	Turns the auto standby function on and off.

Changing the settings

1 Press the [UTILITY (WAKE UP)] button for over 1 second.

[UTILITY (WAKE UP)] indicator lights.

2 Press the [BEAT ◀, ▶] button.

Select the setting item.

3 Press the [TAP] button.

The values set for each field are displayed.

4 Press the [BEAT ◀, ▶] button.

Change the setting value.

5 Press the [TAP] button.

Enter the setting value.

The previous screen reappears.

- To return to the previous screen without changing the settings, press the [AUTO/TAP] button.

6 Press the [UTILITY (WAKE UP)] button.

The [UTILITY] screen closes.

The [UTILITY (WAKE UP)] indicator turns off.

Returning to default settings

1 While pressing and holding the [UTILITY (WAKE UP)] button, press the [POWER] button.

[FACTORY RESET] mode is displayed.

2 Press the [BEAT ◀, ▶] button.

Select [YES].

3 Press the [TAP] button.

Enter the setting value.

4 Press the [POWER] button.

Turn off the power of this unit.

About the auto standby function

When [AUTO STANDBY] is set to [ON], the unit automatically enters the standby mode if 10 hours elapses with all of the following conditions met.

- None of this unit's buttons or controls are operated.
- No audio signal is input to any channel of this unit.
- Pressing the [UTILITY (WAKE UP)] button cancels the standby state.
- This unit is shipped with the auto standby function turned on. If you do not want to use the auto standby function, set [AUTO STANDBY] to [OFF].
- When in standby state, the [UTILITY (WAKE UP)] indicator lights.

About the talk over function

The talk over function has the two modes described below.

- **[ADVANCED]** (advanced talk over): Only the mid-range sound of the sound of the channels other than the **[MIC]** channel is attenuated according to the **[LEVEL]** setting value and the output.

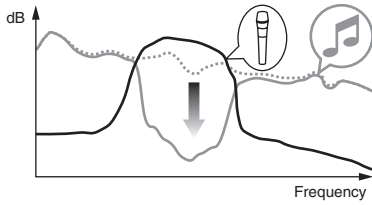

- **[NORMAL]** (normal talk over): The sound of the channels other than the **[MIC]** channel is attenuated according to the **[LEVEL]** setting value and the output.

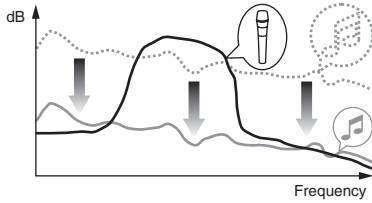

Setting utility software

The setting utility can be used to perform the checks and settings described below.

- Checking the status of this unit's input selector switches
- Setting sound output from this unit to the computer
- Adjusting the buffer size (when using Windows ASIO)
- Checking the version of the firmware and driver software

Displaying the setting utility

For Windows

Click **[Start]** menu > **[All Programs]** > **[Pioneer]** > **[DJM-750MK2]** > **[DJM-750MK2 Settings Utility]**.

For Mac OS X

Click **[Macintosh HD]** icon > **[Application]** > **[Pioneer]** > **[DJM-750MK2]** > **[DJM-750MK2 Settings Utility]**.

Checking the status of this unit's input selector switches

Display the setting utility before starting.

Click the **[MIXER INPUT]** tab.

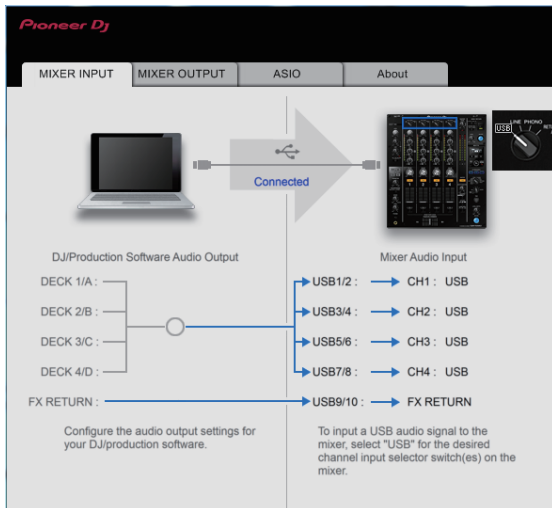

FX RETURN can be used with compatible software.

Setting sound output from this unit to the computer

Display the setting utility before starting.

1 Click the **[MIXER OUTPUT]** tab.

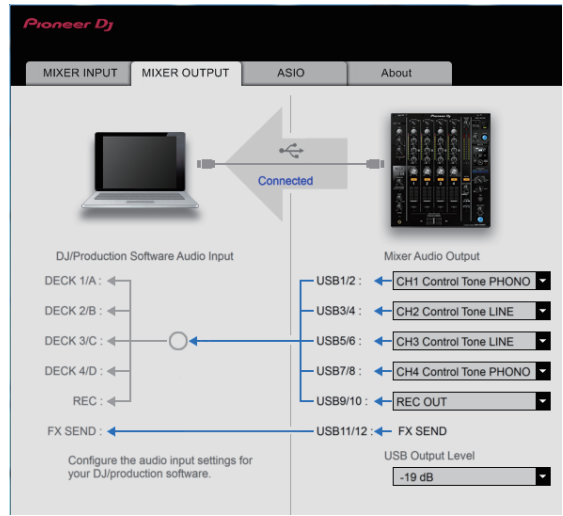

2 Click the **[Mixer Audio Output]** pull-down menu.

Select the audio to be output to the computer from the audio signals of this unit.

- For details on the **[Mixer Audio Output]** pull-down menu list, see page 24

3 Click the **[USB Output Level]** pull-down menu.

Adjust the volume of sound output from this unit.

- The **[USB Output Level]** setting is applied equally to all audio data. However, when **[T]** on the table in step 2 is selected, the sound is output at the same volume level as the sound input to this unit.
- If the volume is not loud enough after adjusting the volume of the DJ software, change the **[USB Output Level]** setting to adjust the volume of sound output from this unit. Note that the sound will be distorted if the volume is raised too high.
- **[FX SEND]** and **[Control Tone]** can be used with supported software.

Adjusting the buffer size (when using Windows ASIO)

If an application using this unit as the default audio device (DJ software, etc.) is running, quit the application before adjusting the buffer size. Display the setting utility before starting.

Click the **[ASIO]** tab.

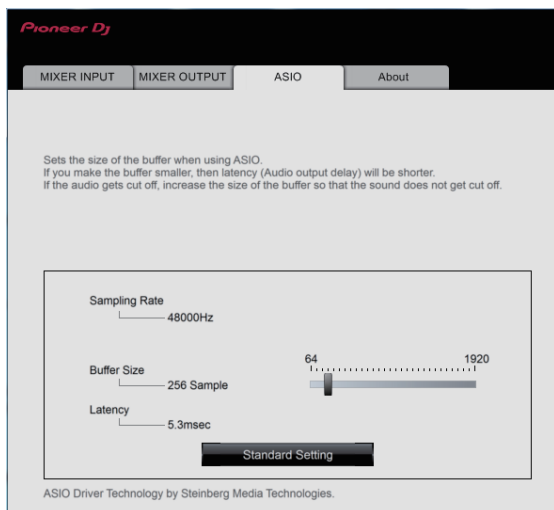

- If a large buffer size is set, drops in audio data (breaks in the sound) occur less easily, but the time lag due to the delay in the transfer of the audio data (latency) increases.

Checking the version of the firmware and driver software

Display the setting utility before starting.

Click the **[About]** tab.

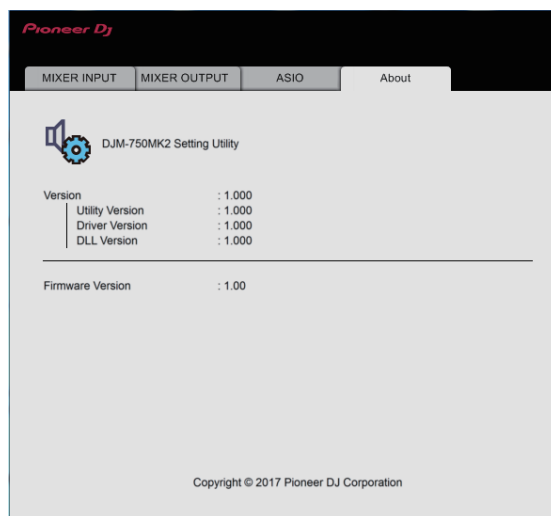

Checking the latest information on the driver software

For the latest information on this unit's dedicated driver software, access the following Pioneer DJ support site.

pioneerdj.com/support/

- Operation cannot be guaranteed when multiple units of this mixer are connected to a single computer.

[Mixer Audio Output] pull-down menu list

CH1 (USB1/2)	CH2 (USB3/4)	CH3 (USB5/6)	CH4 (USB7/8)	CH5 (USB9/10)	CH6 (USB11/12)
CH1 Control Tone PHONO ^[1]	CH2 Control Tone PHONO ^[1]	CH3 Control Tone PHONO ^[1]	CH4 Control Tone PHONO ^[1]	REC OUT ^[2]	FX SEND ^[3]
CH1 Control Tone LINE ^[1]	CH2 Control Tone LINE ^[1]	CH3 Control Tone LINE ^[1]	CH4 Control Tone LINE ^[1]	Post CH1 Fader ^[2]	—
Post CH1 Fader ^[2]	Post CH2 Fader ^[2]	Post CH3 Fader ^[2]	Post CH4 Fader ^[2]	Post CH2 Fader ^[2]	—
CROSS FADER A ^[2]	CROSS FADER A ^[2]	CROSS FADER A ^[2]	CROSS FADER A ^[2]	Post CH3 Fader ^[2]	—
CROSS FADER B ^[2]	CROSS FADER B ^[2]	CROSS FADER B ^[2]	CROSS FADER B ^[2]	Post CH4 Fader ^[2]	—
MIC	MIC	MIC	MIC	CROSS FADER A ^[2]	—
REC OUT ^[2]	REC OUT ^[2]	REC OUT ^[2]	REC OUT ^[2]	CROSS FADER B ^[2]	—
—	—	—	—	MIC	—

- ^[1] Can be used with compatible software. The sound is output at the same volume level as the sound input to this unit, regardless of the **[USB Output Level]** setting.
- ^[2] When using these functions for applications other than recording, pay attention to the DJ application's settings so that no audio loops are generated. If audio loops are generated, sound may be input or output at unintended volumes.
- ^[3] Can be used with compatible software. Settings cannot be changed.

Additional information

Troubleshooting

- If something is wrong with this unit, check the following issues, and also access the Pioneer DJ site and check [FAQ] for [DJM-750MK2].
pioneerdj.com/support/
- This unit may not operate properly due to static electricity or other external influences. In such cases, disconnect the power cord and connect it again to restore normal operation.

Problem	Check	Remedy
The unit does not turn on.	Is the power cord properly connected?	Connect the power cord to an AC outlet.
Sound is not output, or sound is too small.	Is the input selector switch set to the proper position?	Change the input source for the channel using the input selector switch. (page 10)
	Are the connection cables properly connected?	Connect the connection cables properly. (page 7)
	Are the terminals and plugs dirty?	Clean the terminals and plugs before connecting them to the unit.
	Is the [ATT.] for [MASTER OUT] set to [-6 dB], etc.?	Switch the [ATT.] switch for [MASTER OUT] on the [UTILITY] screen.
Sound is distorted.	Is the level of sound output from the [MASTER] channel appropriately set?	Adjust the [MASTER LEVEL] control so that the master channel level indicator lights up around [0 dB] at the peak level. (page 10) On the [UTILITY] screen, set the [ATT.] of [MASTER OUT] from [-6 dB] to [-12 dB].
	Is the level of sound input to each channel properly set?	Adjust the [TRIM] control so that the channel level indicator lights up at about [0 dB] at the peak level. (page 10)
The crossfader function does not work.	Are the [CROSS FADER ASSIGN (A, THRU, B)] selector switches properly set?	Set the [CROSS FADER ASSIGN (A, THRU, B)] selector switches for the different channels properly. (page 10)
BEAT FX does not work.	Is the effect channel selector switch set to the proper position?	Turn the effect channel selector switch to select the channel to which you want to apply the effect.
	Is the [FX FREQUENCY] button set correctly?	Press the [FX FREQUENCY] button for the band that you want to apply the effect to, so that it lights.
SOUND COLOR FX does not work.	Is the [COLOR] control set to an appropriate position?	Turn the [COLOR] control clockwise or counterclockwise. (page 11)
Cannot use an external effector.	Is the effect channel selector switch set to the proper position?	Turn the effect channel selector switch to select the channel to which you want to apply the effect.
	Is the [SEND/RETURN ON/OFF] button set to [ON]?	Press the [SEND/RETURN ON/OFF] button and set [SEND/RETURN] to [ON]. (page 12)
	Is the external effector correctly connected to the [SEND] or [RETURN] terminal.	Connect the external effector to the [SEND] and [RETURN] terminals.
	Is the mobile device correctly connected to the mobile device connection terminal.	Connect the mobile device to the mobile device connection terminal and launch a compatible application.
	Is the [RETURN TYPE (AUX, INSERT)] selector switch set correctly?	Set the [RETURN TYPE (AUX, INSERT)] switch to the correct position.
	Is the [SEND/RETURN (1/4" JACK, ) selector switch set correctly?	Set the [SEND/RETURN (1/4" JACK, ) selector switch correctly.
Sound from the external effector is distorted.	Is the external effector's audio output level set to an appropriate level?	Adjust the external effector's audio output level.
Tempo (BPM) cannot be measured or measurement value of tempo (BPM) is implausible.	Is the audio input level too high or too low?	Adjust the [TRIM] control so that the channel level indicator lights up at about [0 dB] at the peak level. (page 10) For some tracks, it may not be possible to measure the tempo (BPM). Use the [TAP] button to input the tempo manually.
Measured tempo (BPM) differs from tempo indicated on CD.	—	The values may differ slightly due to the different ways in which the BPM is measured.
MIDI control does not work.	Are the MIDI settings properly set?	To operate software with this unit, the MIDI messages on this unit must be assigned to the software you are using. For the assignment method, see your software's operating instructions.
This unit is not recognized after it has been connected to a computer.	Is the driver software properly installed on your computer?	Install the driver software. If it is already installed, reinstall it.
Sound from the computer cannot be output from this unit.	Are this unit and computer properly connected?	Connect this unit and the computer directly using the included USB cable. (page 7)
	Are the audio output device settings properly set?	Select this unit with the audio output device settings. For instructions on making settings for your application, see your application's operating instructions.
	Is the input selector switch set to the proper position?	Set the input selector switch to the [] position. (page 10)

Problem	Check	Remedy
<p>Sound is distorted when an analog player is connected to the [PHONO] terminals.</p> <p>Or, lighting of the channel level indicator does not change when the [TRIM] control is turned.</p>	<p>Is an analog player with a built-in phono equalizer connected to this unit?</p> <hr/> <p>Is an audio interface for computers connected between the analog player and this unit?</p>	<p>Connect an analog player with a built-in phono equalizer to the [LINE] terminals. (page 7)</p> <hr/> <p>Set the PHONO/LINE selector switch on the analog player to PHONO if available.</p> <hr/> <p>If the output of the audio interface for computers is line level, connect it to the [LINE] terminals. (page 7)</p> <hr/> <p>Set the PHONO/LINE selector switch on the analog player to PHONO if available.</p>

Block Diagram

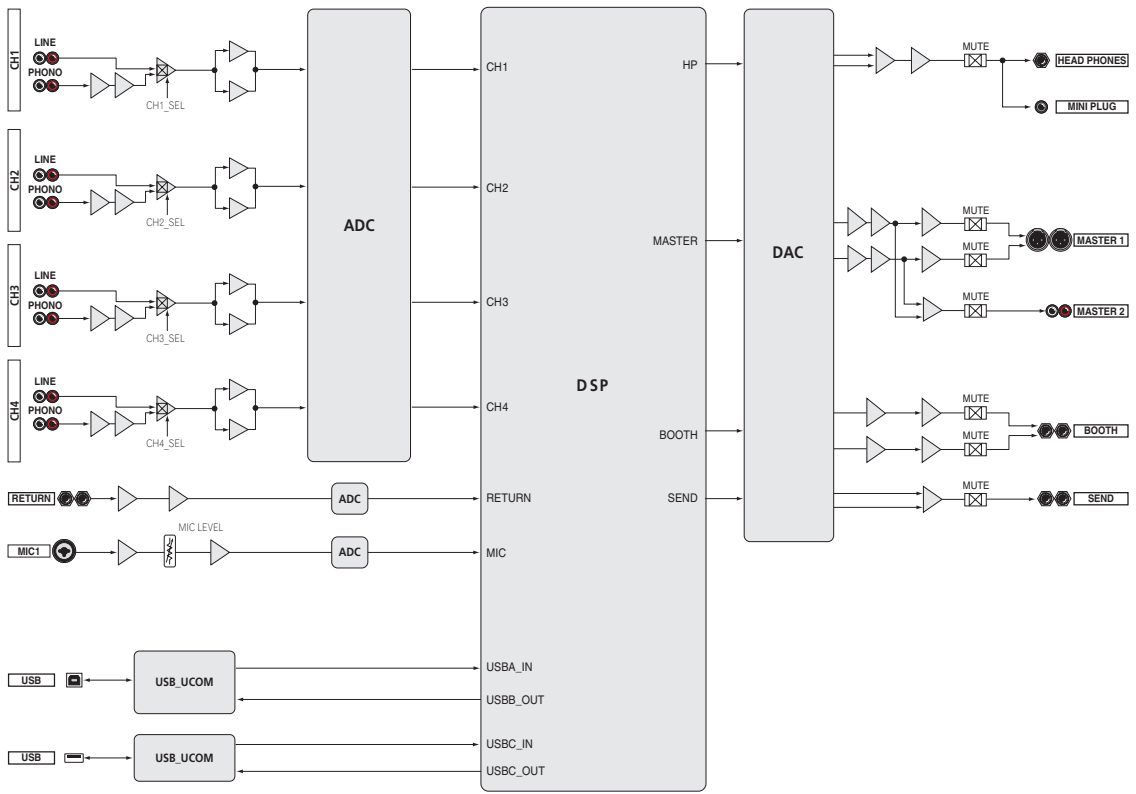

Additional information

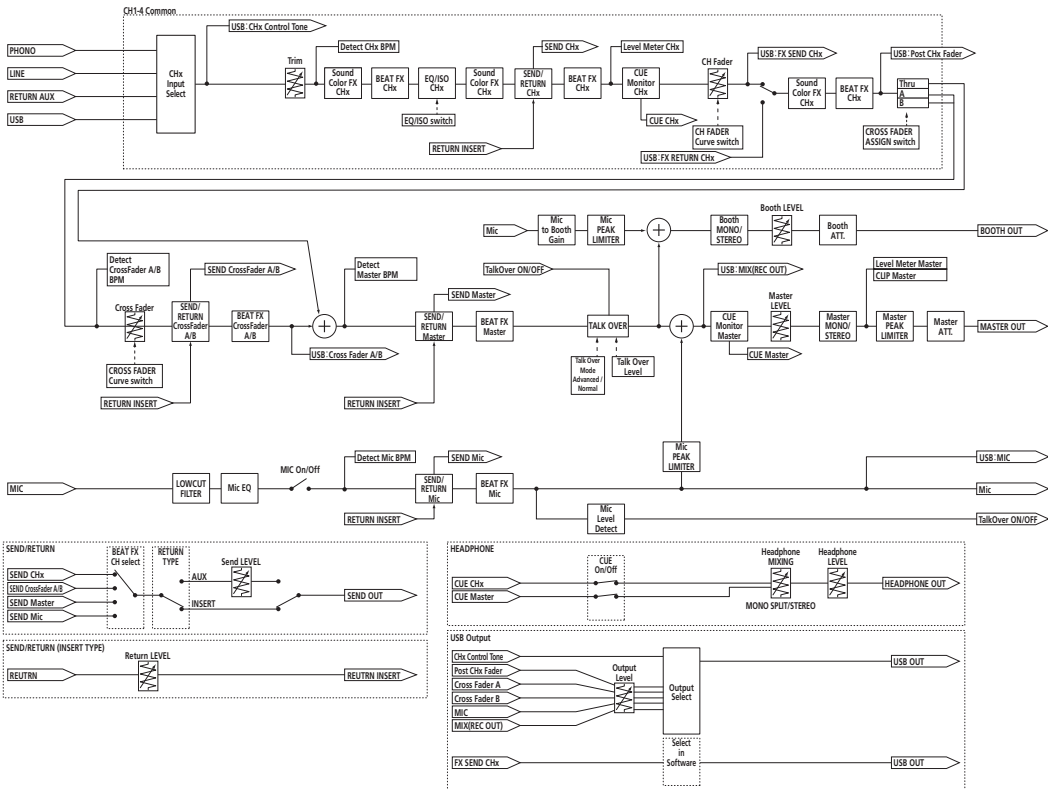

Trademarks and registered trademarks

- “Pioneer DJ” is a trademark of the Pioneer Corporation, and is used under license. rekordbox is a trademark or registered trademark of the Pioneer DJ Corporation.
- Microsoft and Windows are either registered trademarks or trademarks of Microsoft Corporation in the United States and/or other countries.
- Mac OS, iTunes, and Finder are trademarks of Apple Inc., registered in the U.S. and other countries.
- Intel and Intel Core are trademarks of Intel Corporation in the U.S. and/or other countries.
- ASIO is a trademark of Steinberg Media Technologies GmbH.

The names of companies and products mentioned herein are trademarks or registered trademarks of their respective owners.

Cautions on copyrights

rekordbox restricts playback and duplication of copyright-protected music contents.

- When coded data, etc., for protecting the copyright is embedded in the music contents, it may not be possible to operate the program normally.
- When rekordbox detects that coded data, etc., for protecting the copyright is embedded in the music contents, processing (playback, reading, etc.) may stop.

Recordings you have made are for your personal enjoyment and according to copyright laws may not be used without the consent of the copyright holder.

- Music recorded from CDs, etc., is protected by the copyright laws of individual countries and by international treaties. It is the full responsibility of the person who has recorded the music to ensure that it is used legally.
- When handling music downloaded from the Internet, etc., it is the full responsibility of the person who has downloaded the music to ensure that it is used in accordance with the contract concluded with the download site.

— The specifications and design of this product are subject to change without notice.

© 2017 Pioneer DJ Corporation. All rights reserved.

<DR11470-B>